

(Roof pattern from combined halves of split plan)

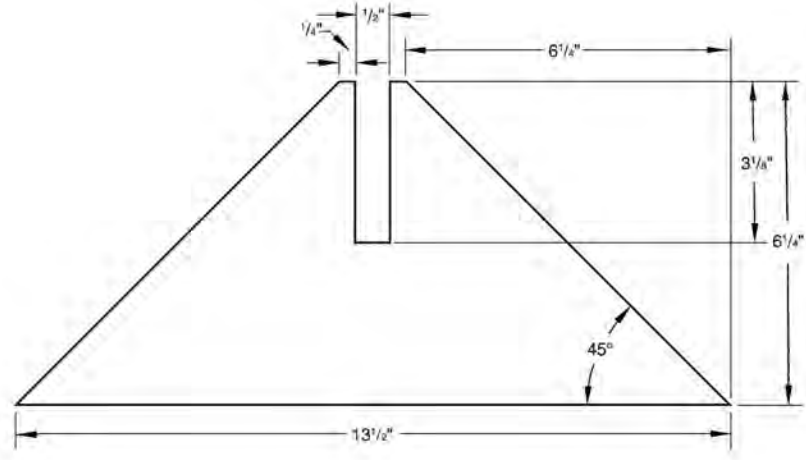

Roof Support #1
 $1/2" \times 6 1/4" \times 13 1/2"$

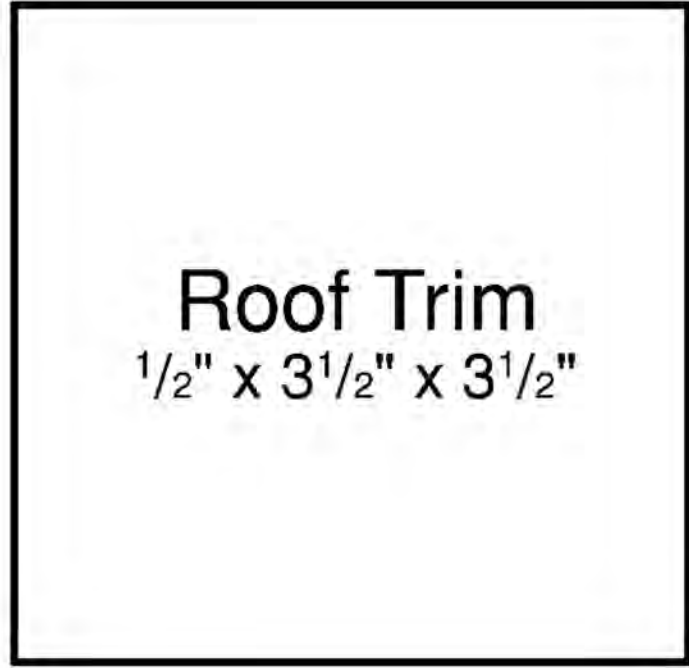
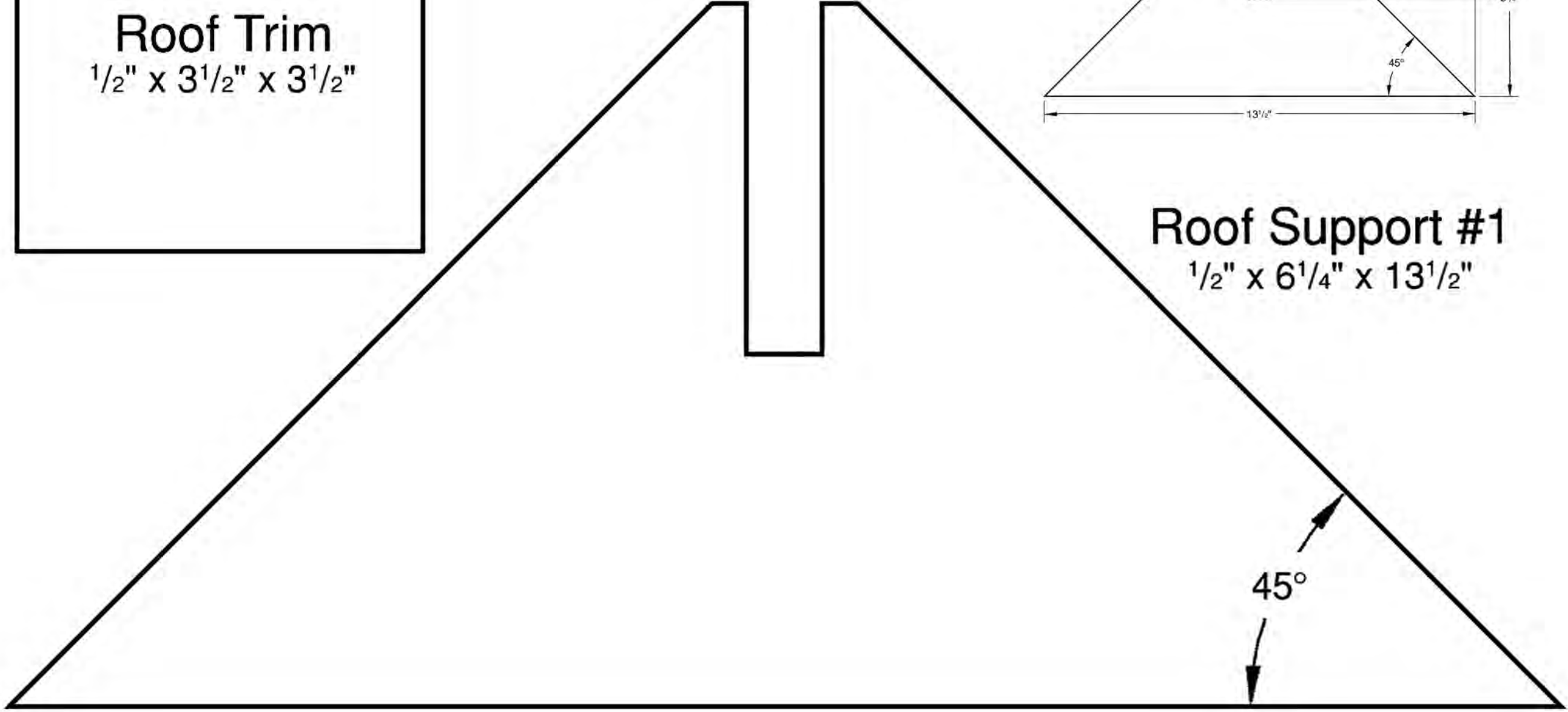

Roof Support #2
1/2" x 6 1/4" x 13 1/2"

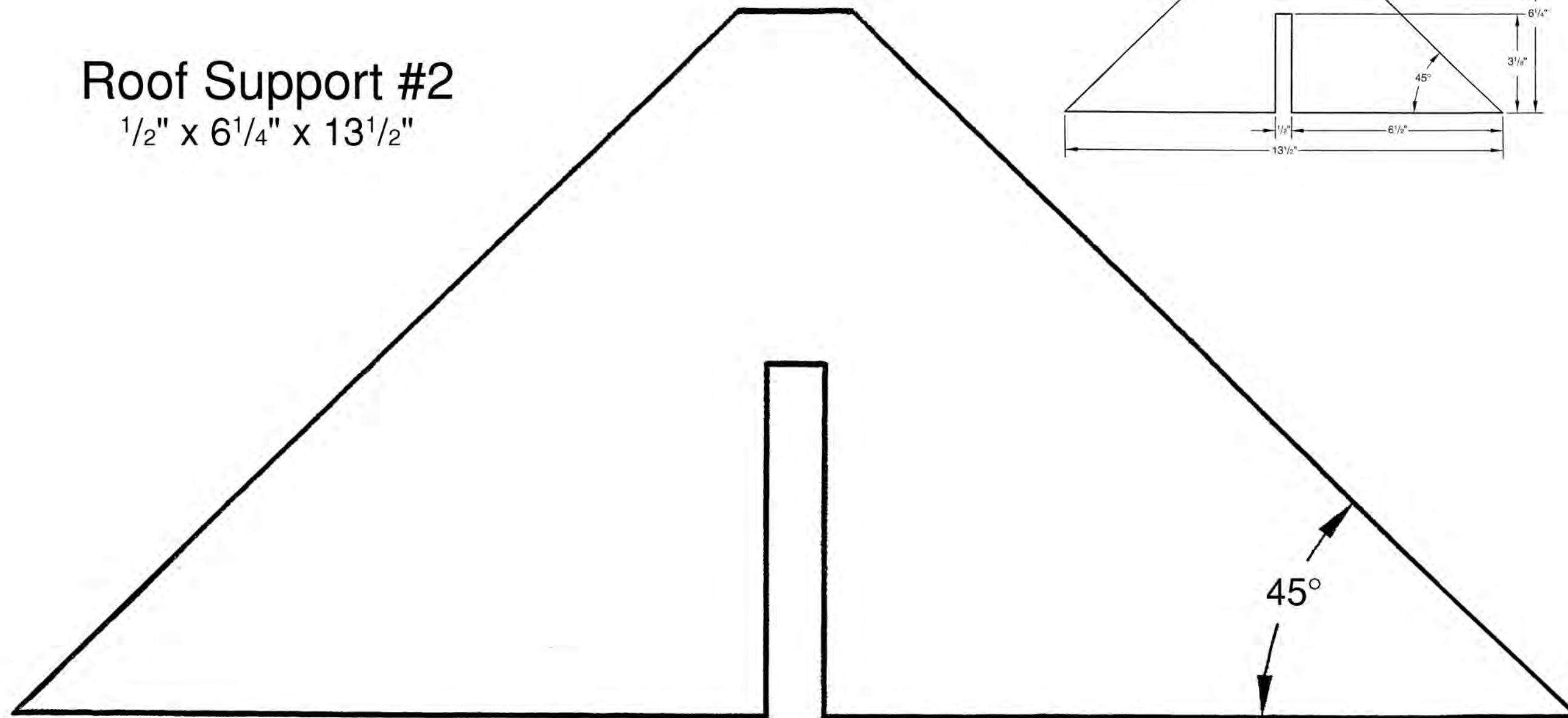

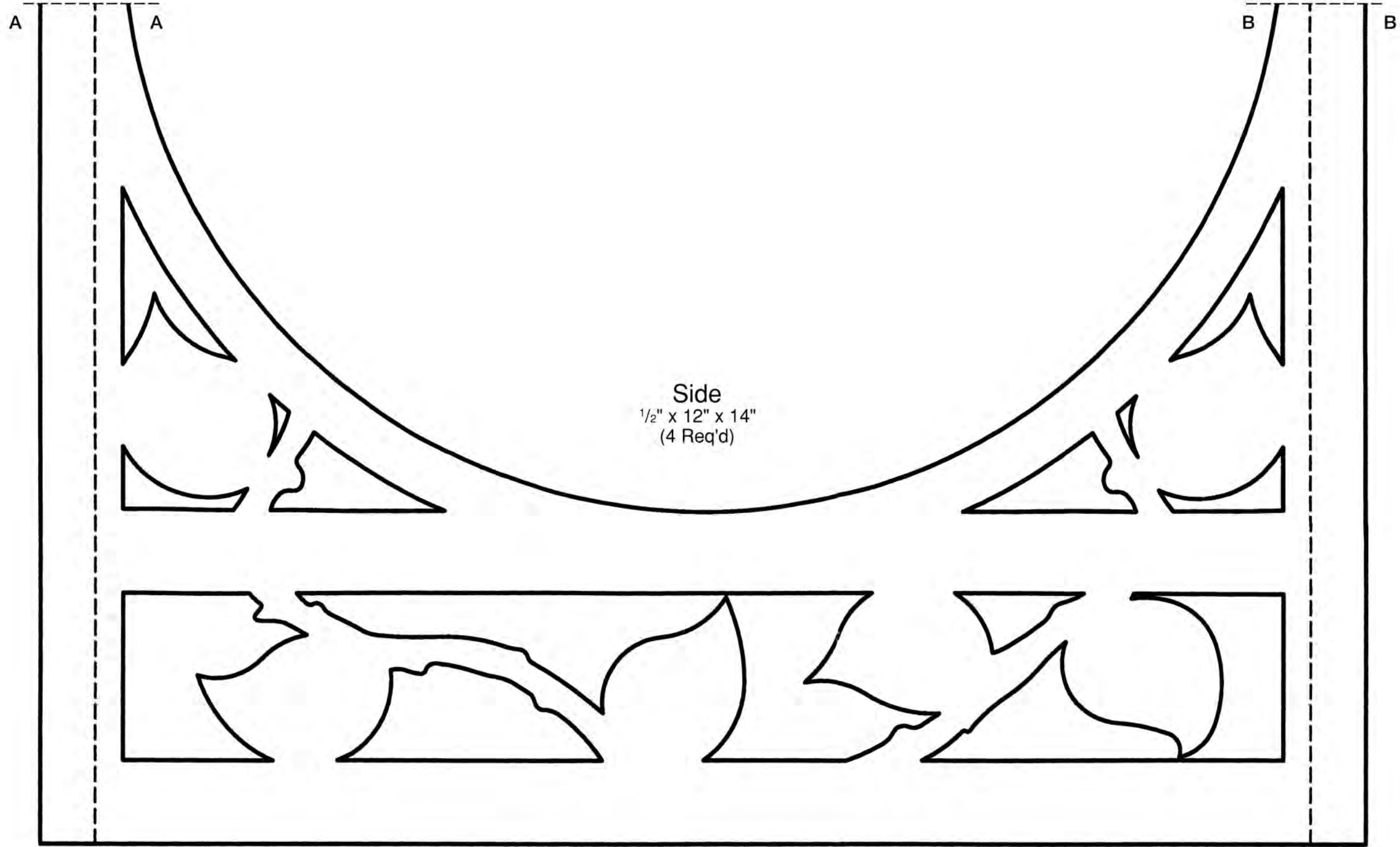

Side
1/2" x 12" x 14"
(4 Req'd)

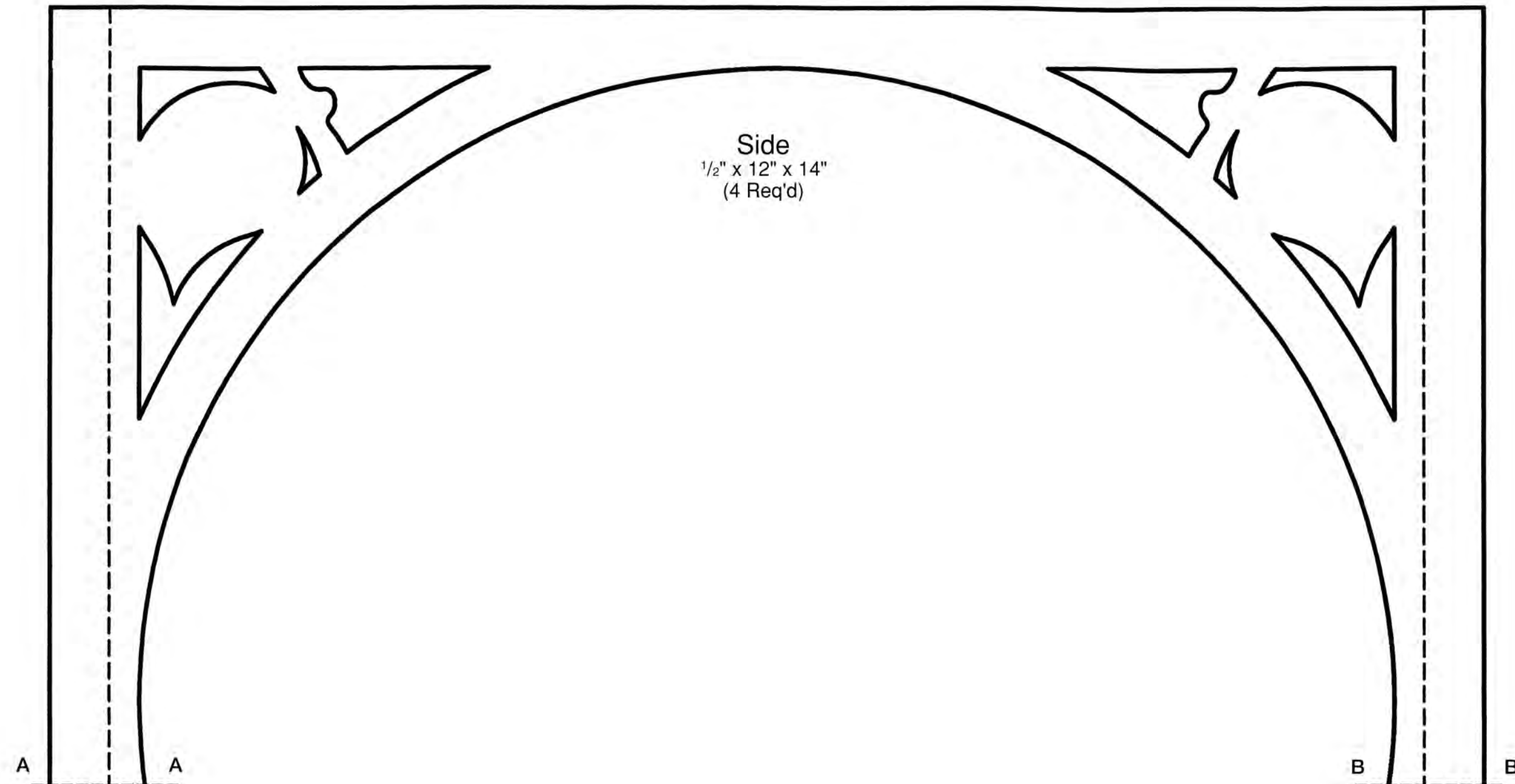

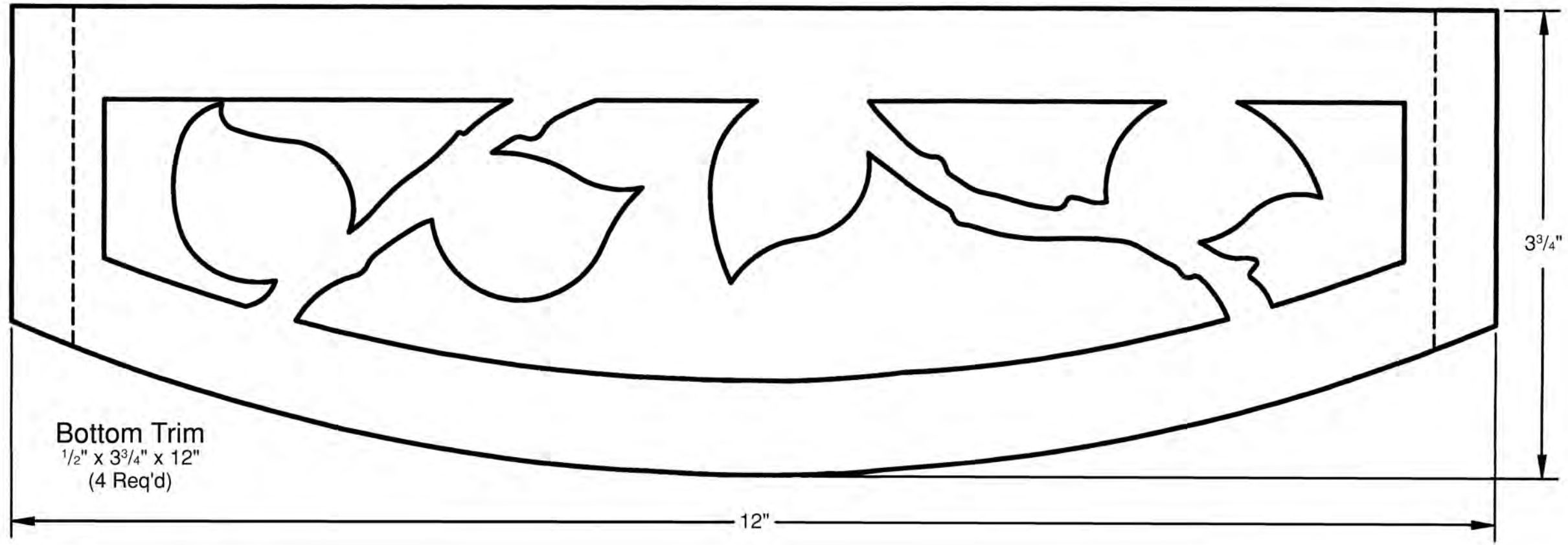

Bottom Trim
1/2" x 3/4" x 12"
(4 Req'd)

12"

3/4"

Reproduce second half to make full pattern

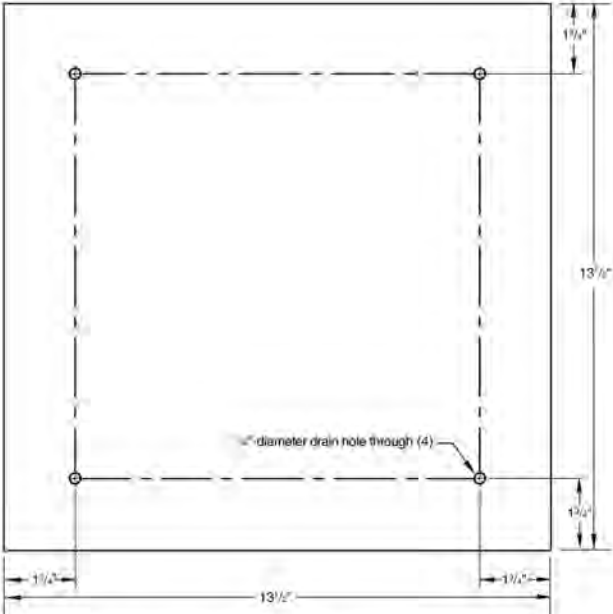

(Top/Bottom pattern from combined halves of split plan)

Top / Bottom
1/2" x 13 1/2" x 13 1/2"
(2 Required)

1/4"-diameter drain hole through (4)

